



Technical datasheet

PVT20000/IRC



Brand	EREA
Article Number	PVT20000/IRC
EAN-code Barcode	5414503118509
Code	11850
Product type	Three-phase transformer - Low inrush current
Primary Voltage	3x 230V Δ -- 3x 400V Y+N
Secondary Voltage	3x 400V Y+N
Power	20 000 VA
Standards	EN 61558-2-4

General properties

Applications	For PV installations	Maximum ambient temperature ta	40 °C
Protection class	Prepared for protection class I	Temperature class transfo	B
Degree of protection	IP00	Finishing	Vacuum- and pressure- varnish impregnated

Electrical properties

Frequency	50-60 Hz	Efficiency	97,3 %
Po	60 W	Pcu	500 W
Dielectric Strength	4500 Vac	Insulation resistance	200 MΩ
Dielectric strength referred to frame	2500 Vac	Specific property	Primary not connected, secondary star connected
Voltage drop (dU%)	2,5 %	Short-circuit voltage (Ucc %)	-
Recommended fuse PRI	C50A (3x230V Δ) C32A (3x400V Y+N)	Recommended fuse SEC	C32A (3x400V Y+N)

Mechanical properties

Primary connection	Screw terminals 10 mm ²
Secondary connection	Screw terminals 10 mm ²
Fixation	Supports with fixing holes

Protection case

Housing IP20	K20PVT/020
Housing IP23	K23PVT/020
Housing IP44	K44EI400/030

Dimensions/weight

Dimensions AxBxC	480x400x415 mm
Dimension D	320 mm
Dimension E	240 mm
Dimension Φ	11 mm
Weight	185 kg

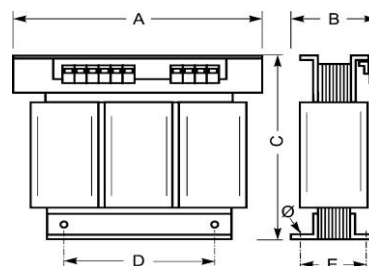



Connection diagram PVT20000/IRC

400V Y+N → 400V Y+N

230V Δ → 400V Y+N

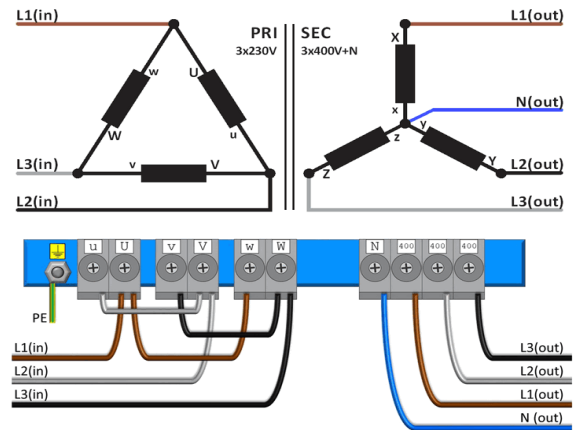
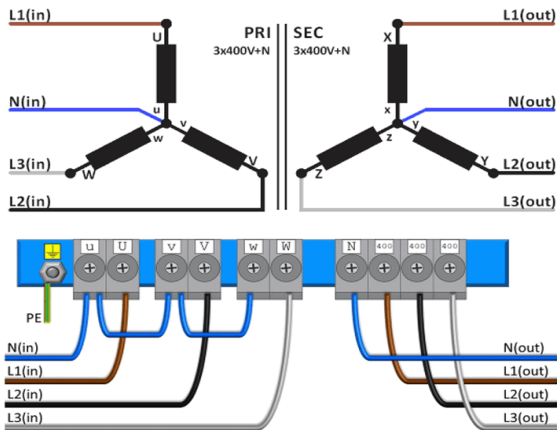



Accessories PVT20000/IRC

IP20 housing

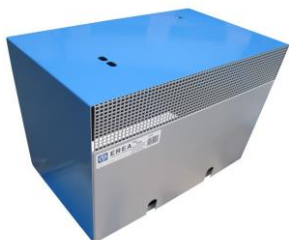

K20PVT/020

IP23 housing



K23PVT/020

Vibration damper

(4 pieces needed per transformer)



Silent block 50



rev. 30.11.2020